

Tech Notes

NATIONAL PARK SERVICE
U.S. DEPARTMENT OF INTERIOR
WASHINGTON, D.C.

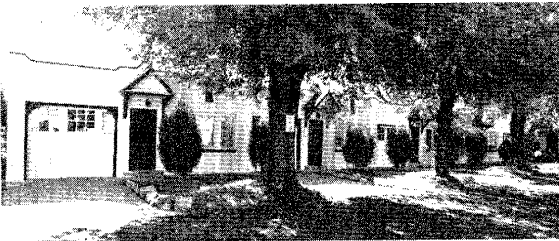

Mountain View Motel



Burgess Carriage House

DOORS**NUMBER 1**

**Historic Garage and
Carriage Doors:
Rehabilitation Solutions**

Bonnie J. Halda, A.I.A.
Division of Cultural Resources
Rocky Mountain Regional Office
National Park Service

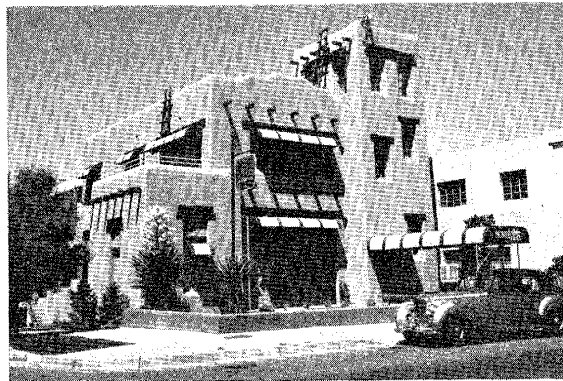

Monte Vista Fire Station

MOUNTAIN VIEW MOTEL, Ogden, Utah

MONTE VISTA FIRE STATION, Albuquerque, New Mexico

BURGESS CARRIAGE HOUSE, Ellicott City, Maryland

Garage, carriage, and freight doors can be important character-defining features of historic buildings. One large door may be the single most prominent element of a carriage house, or the rhythm of several freight doors across an elevation may play a major role in defining the character of a warehouse. The design of the door itself, not just the opening, is often significant. For these reasons, large utilitarian doors in historic buildings should be treated with sensitivity. This Tech Note presents the successful reuse of garage or carriage doors in three separate projects. Two of the three buildings are individually listed in the National Register of Historic Places, and all feature prominent doors which ceased to function as vehicular access after rehabilitation.

Developed between 1931 and 1939 as an auto court, the Mountain View Motel is the oldest and best-preserved motel in Ogden, Utah. The complex consists of seven buildings in the

Mission Revival Style. Two of the buildings feature individual motel units, each with its own attached one-car garage, a characteristic of many motels during this period.

The Monte Vista Fire Station, constructed in 1936 in Albuquerque, New Mexico, is the only known Spanish/Pueblo Revival style fire station in the country. The fire station was a Workers Progress Administration (WPA) project and its style of architecture, based on Indian pueblos, typifies the WPA interest in supporting regional architecture.

The Burgess Carriage House was built in the 1870s in conjunction with an adjacent wagon shop and was used as a paint shop for carriages and wagons. Located in the Ellicott City National Register Historic District in Maryland, it is characteristic of the numerous 19th century businesses that emerged around the town's flourishing flour trade and manufacturing enterprises.

Carriage and garage doors that contribute to the character of a building should be retained whenever possible. Alterations should be undertaken only when necessary and all work should be done in a sensitive manner.

MOUNTAIN VIEW MOTEL

Rehabilitation Design Problem

Conversion of the Mountain View Motel into apartments was problematic due to the fact that bedrooms were to be located in the former garage spaces and building codes required adequate light, ventilation, and egress. The 20 existing garage doors, which operated by sliding along interior overhead tracks, were in good condition but insulation and operable windows were needed.

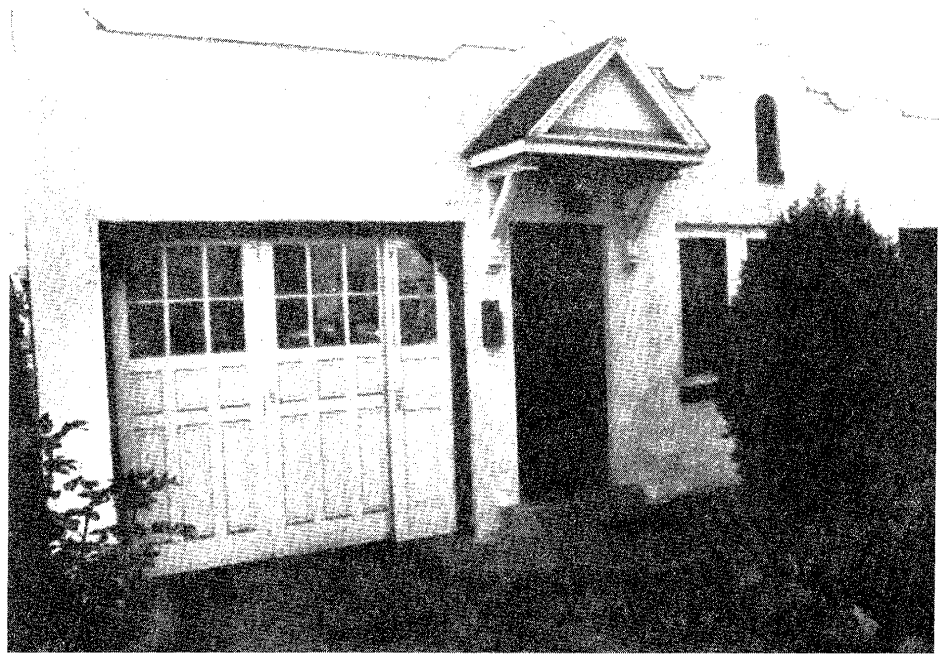
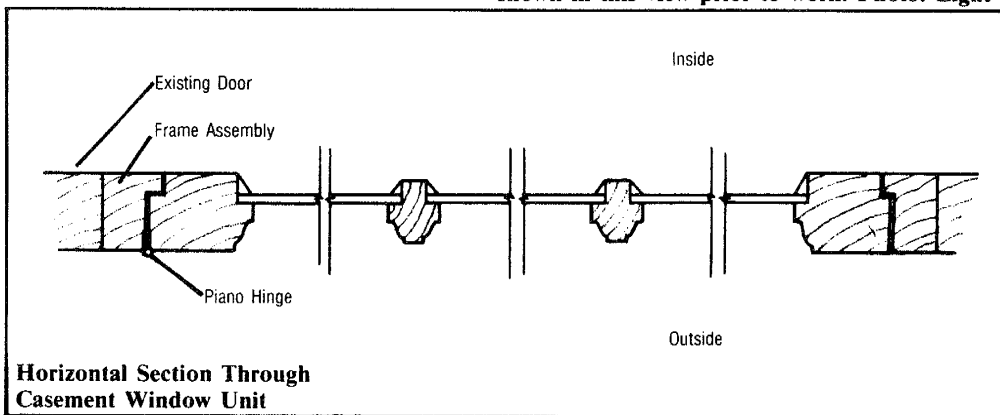
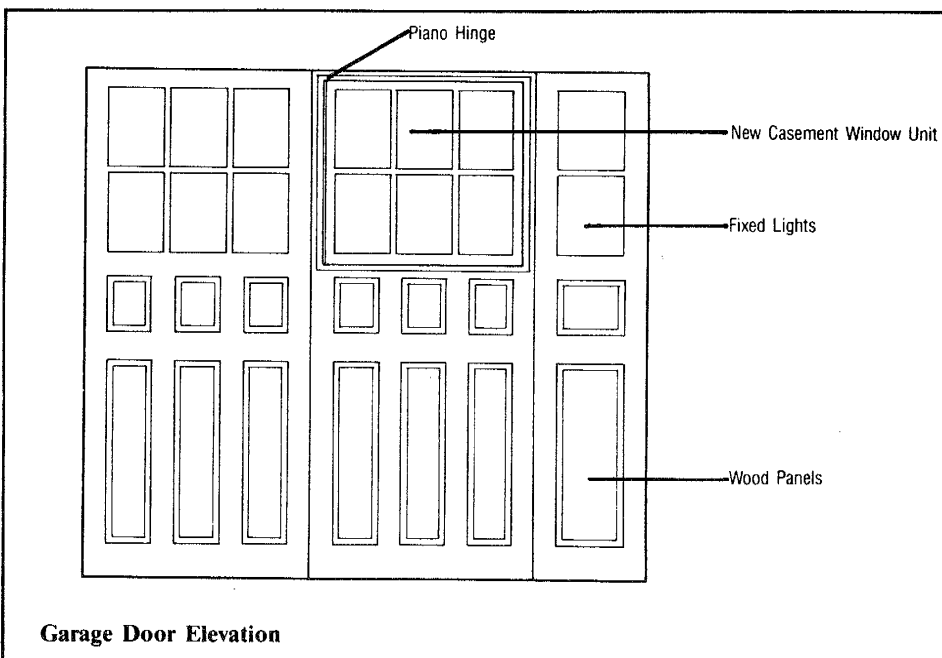

Figure 1. The attached garages were an integral part of the design of the motel, as shown in this view prior to work. Photo: Light Images



Horizontal Section Through Casement Window Unit



Garage Door Elevation

Figure 2. The existing doors were retrofitted by removing one window and installing an operable casement window. Drawings: Bonnie J. Halda, A.I.A.

Rehabilitation Design Solution

The owners of the Mountain View Motel recognized the attached garages as an important component of the historic resource and from the beginning examined ways of retaining the existing doors (see figure 1). The final design called for re-installing the doors in their historic position within the garage opening and constructing a new stud wall on the interior. This provides needed insulation for the bedrooms while preserving the doors on the exterior.

The interior wall was built with an opening the same size and location as the window opening in the door. To provide ventilation and emergency egress, one section of multipaned windows in each set of doors was cut out. A millwork company fashioned a custom window unit to match the

configuration of the removed window, and the new unit was installed flush with the plane of the surrounding garage door (see figure 2). A piano hinge allows the custom window unit to operate as an out-swinging casement (see figure 3). The piano hinge is only slightly visible from the exterior and all other hardware is interior mounted. When closed, the new operable window appears as part of the garage door. The owner elected to leave the track hardware from the doors in place on the interior as evidence of the former garage converted to a bedroom (see figure 4).

Project Evaluation

The casement design window retrofitted in the original door could accommodate additional features if required in other projects. Insect screens could be installed on the room side, since a worm-gear sash operator is used. Furthermore, removable interior storm panels or inside casements could be installed on the room side for enhanced energy performance.

In this particular project, the sensitive treatment of the garage entrances permitted not only the retention of the original doors, but also allowed the early motel complex to retain the historic design element of the attached garages.



Figure 3. The new casement windows in the garage doors are visible only when the windows are open. Photos: Light Images

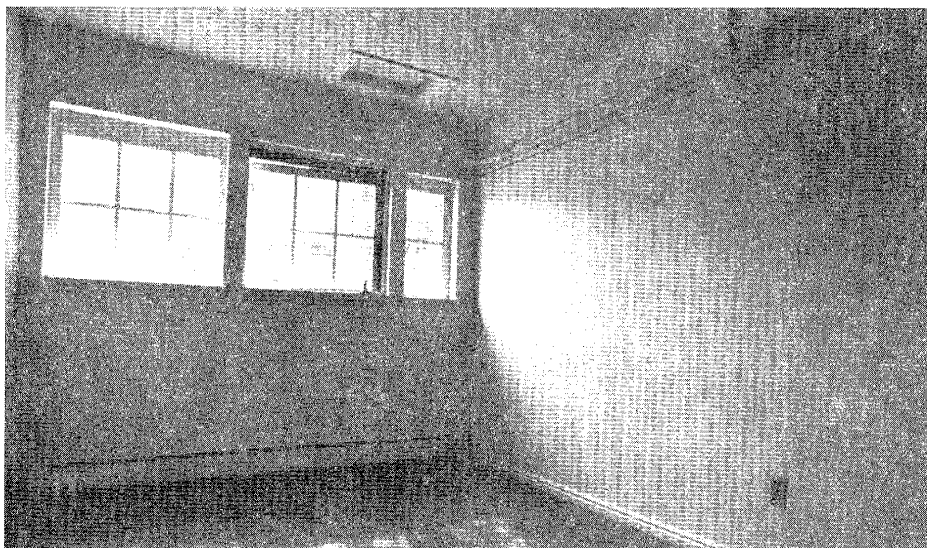

Figure 4. The original garage door hardware was retained on the interior. Photo: Light Images

MONTE VISTA FIRE STATION

Rehabilitation Design Problem

The plan of the new restaurant proposed for the Monte Vista Fire Station called for the dining room to be located in the former truck bay. The dining room needed both light and views; however, the existing historic doors in the truck bay did not meet this requirement. The 14-foot-high doors featured wood cross-bracing over tongue-and-groove boards in the upper and lower third sections, and multipaned glass lights in the central third sections (see figure 5). Overhead operating hardware allowed the doors to fold open quickly in the event of an alarm. One portion of the doors had been modified to accommodate a pedestrian door, but were in otherwise good condition. The doors were recognized as significant features of the building, but their small amount of glass did not provide adequate light or views and the poor fit of the doors within the opening allowed air infiltration.

The initial proposal for treatment of the garage doors specified that the original ones would be fixed in the open, folded position on the interior and new, contemporary infill would be installed. The infill would incorporate a large amount of glass in order for the doorway to appear as open as possible. The problem with this solution was that only visitors to the interior of the building would be aware of the original design of the doors. In addition, the openings historically appeared as "solid," and the glass infill would alter the character of the building.

Figure 5. The historic fire truck doors, which featured wood cross-bracing and multipaned windows, played an important role in defining the historic character of the building. Photo: Chip Kaufman

Figure 6. The historic doors were repaired and fixed in place, with the installation of glass behind the cross-bracing. Photo: Chip Kaufman

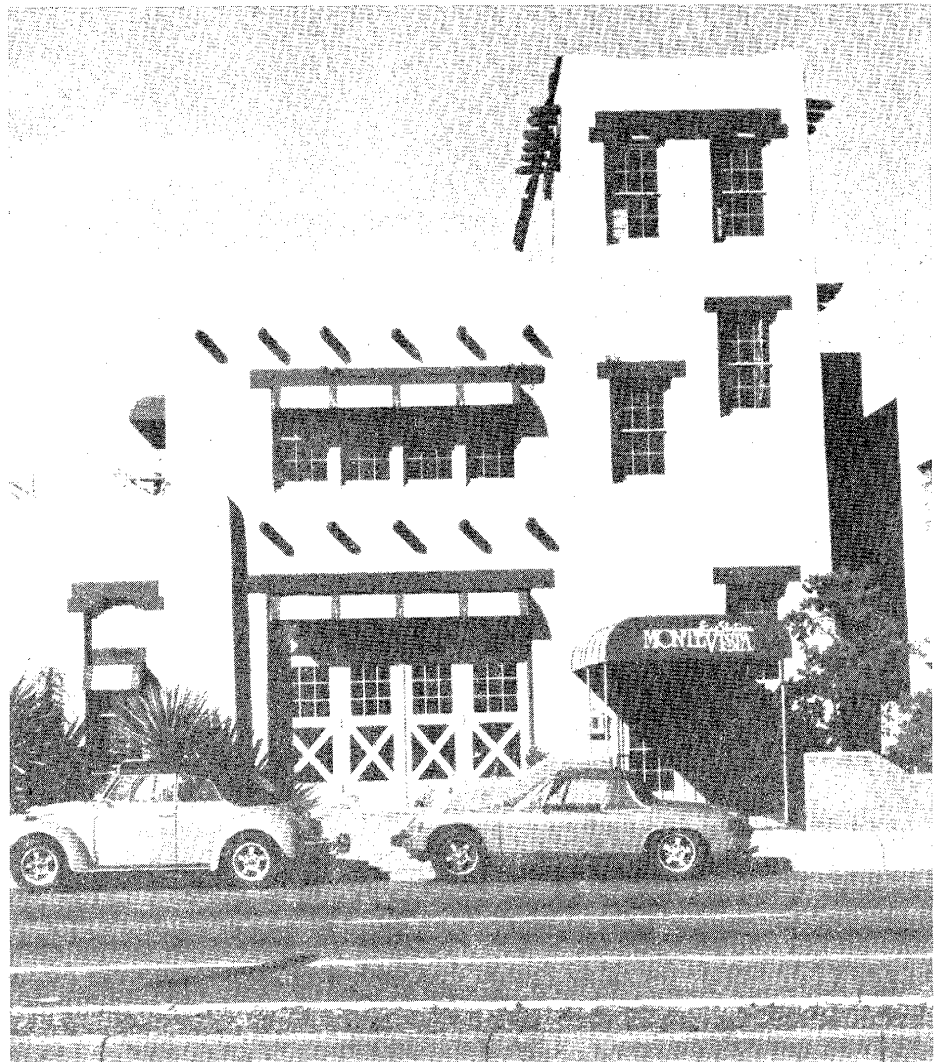
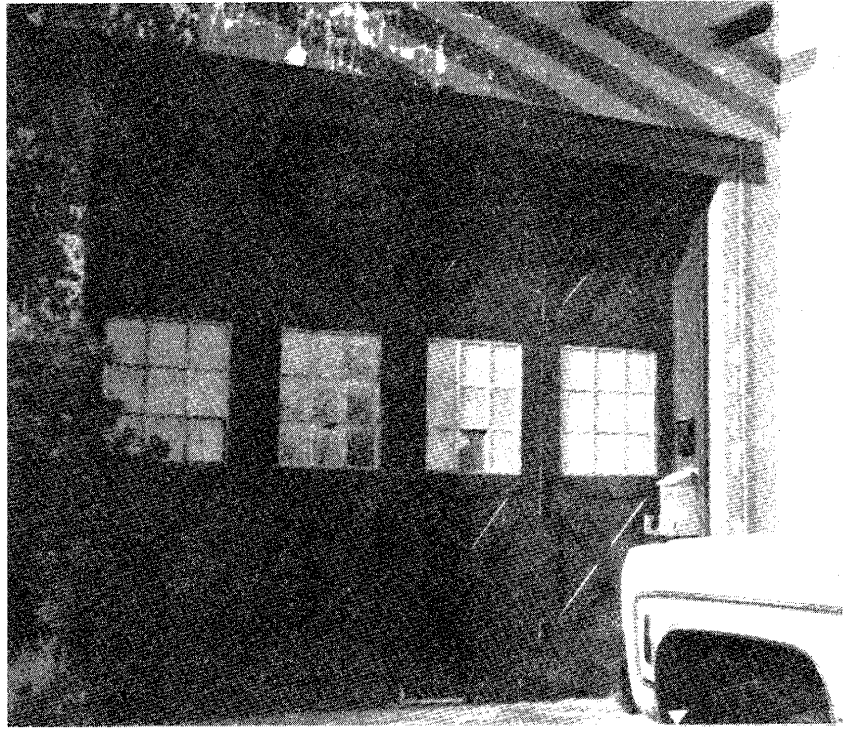

Rehabilitation Design Solution

The decision was made to repair, weatherstrip, and fix in place the existing garage doors. The tongue-and-groove boards behind the cross-bracing in the upper and lower portions of the doors were removed and insulating glass was installed (see figure 6). The actual work on the doors was simple, requiring only a half of a day of labor to remove the boards and install the glass. The new glass lights, together with the glass in the central section of the doors, allows light into the interior and

provides good views to a small landscaped area located in the former driveway. Although there is a large amount of glass incorporated into the doors, the overall impression of the doors, with their heavy wood surrounds, cross-bracing, and multi-paned windows, has been preserved.

Project Evaluation

The customers using the new dining room are able to take advantage of the New Mexican sunshine as well as having pleasant views to the exterior (see figure 7). The innovative design

of the retrofitted doors helps preserve the historic character of the exterior, although the use of glass only in the upper panels would have lessened the impact on the engine room interior, where the doors are even a more prominent feature. An inexpensive solution, it was much preferred to full glass infill or infill with a contemporary design that would have replaced the historic doors in their entirety. The chosen solution also has the advantage of being easily changed back to the original design by simply re-installing diagonal paneling, if dictated by future commercial uses.

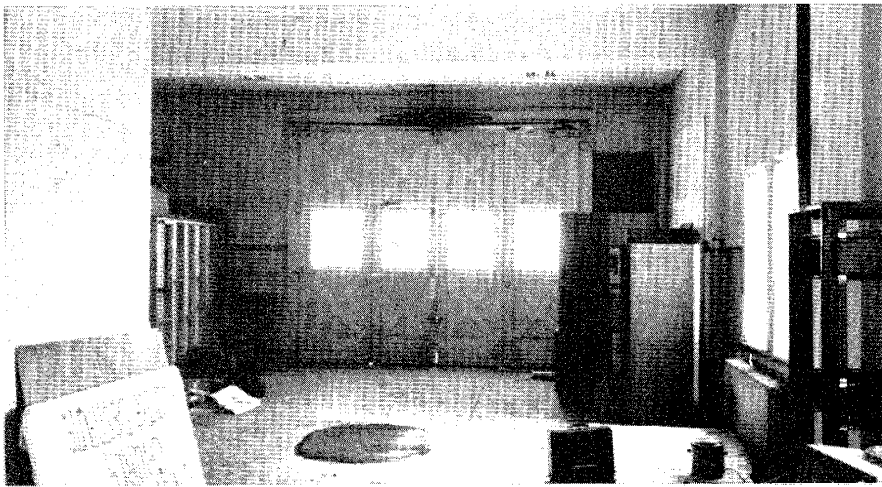
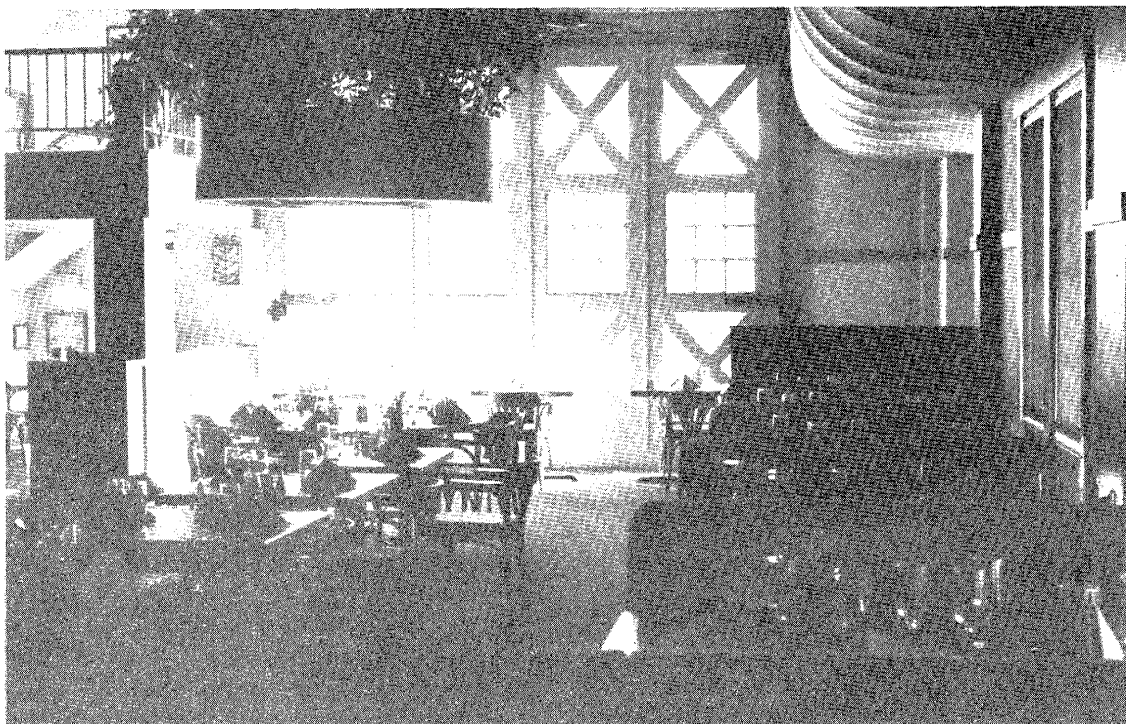

Figure 7. Replacing the tongue-and-groove boards with glass opened up the former fire truck bay while retaining the character of the doors.
Photos: Chip Kaufman



BURGESS CARRIAGE HOUSE

Rehabilitation Design Problem

The conversion of this 1870s carriage house to a shop necessitated creation of a customer entrance on the main level. Lacking any entrance other than through the carriage doors, a passageway needed to be created that would not alter the building's historic appearance (see figure 8). The rather formal front elevation of this utilitarian structure consisted of double-hung windows flanking the wooden carriage doors and had survived unaltered since the 19th century. The initial plan to convert one of the two windows into an entrance door would have broken the symmetrical fenestration pattern across the front and the existing doors were too large for customer use. Alternatively, locating an entrance door within one of the carriage doors would have had even a worse impact on the building's historic appearance.

Design Solution

Having decided to locate the customer's entrance on the side of the building, another set of problems was created. Since the ground sloped

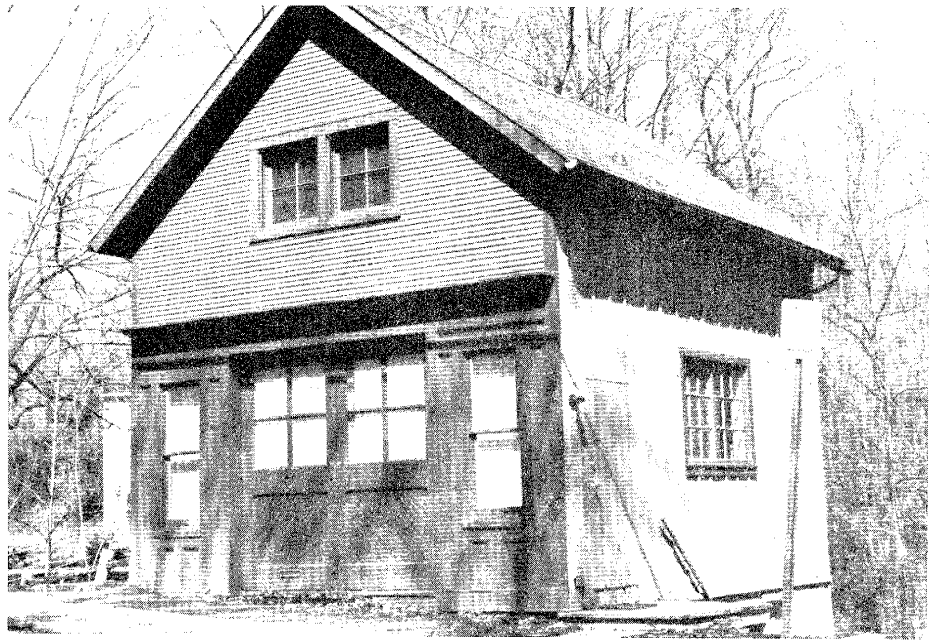
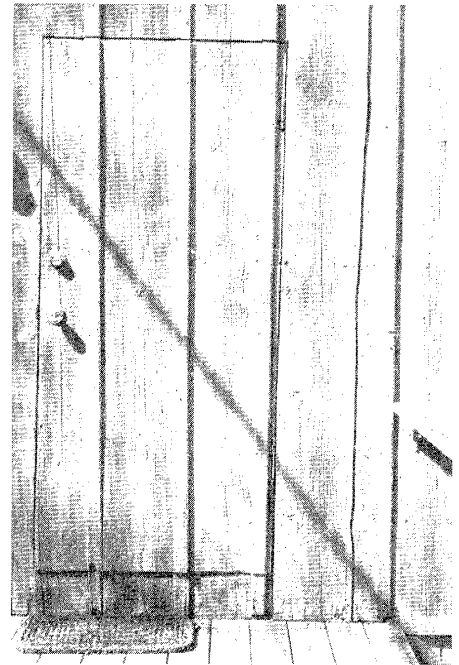

Figure 9. A new customer entrance was created through construction of a door along the side. The concealed nature of the door minimized its impact on the building's historic appearance. Photos: Charles Fisher

sharply from front to back, a side entrance could only be installed close to the front. The highly visible nature of the two side elevations, with their simple board and batten walls broken only by a pair of sliding windows, meant that a normal door would be quite prominent. Furthermore, the height of the new side door in very close proximity to the front facade would be a further issue since the scale of a modern door would be at odds with the height, massiveness, and formal design of the front elevation. The solution was to create a



“hidden” entrance, utilizing the original board and batten as facing for the door (see figure 9). Since the door would be immediately adjacent to the front, there was no need to have the door serve as a highly visible entrance. The plentiful glass openings across the front and a new unobtrusive sign board were considered sufficient for successful retail use. For a second means of egress, a new stair to the basement would provide passage to the outside off the back of the building.



Figure 8. This 1870s carriage and wagon painters shop never had a customers' entrance other than through the carriage doors. Photo: Charles Fisher

Framing and Trim

The door was designed to consist of 3 layers (see figure 10). The center portion consisted of a sheet of 3/4" exterior grade plywood. On the inside, 1" x 5" clear pine was used along the perimeter face and 1" x 5" beaded pine was installed diagonally within. This detailing was similar to that found in other utilitarian entrances within the community, including the carriage doors on the building (see figure 11). For the outside face of the door, the original

board and battens were reattached in their same position so as to align with the boards above the door.

As part of the plan to downplay the entrance, exterior casing was not used around the new door frame. In fact, the door frame was set back behind the board and batten. Normal door framing and trim would have called unnecessary attention to the entrance. Heavy-duty strap and plate combination hinges were used to hang the door, with the plate against the jamb and the strap secured to the door prior to affixing the board and batten.

Evaluation

The door was cut and assembled in one day, and cost less than \$100 in materials, less hardware. Although the choice of hardware could have been improved upon, the design concept and execution typifies the creative approaches that are often needed in adaptively reusing small carriage houses and garages.

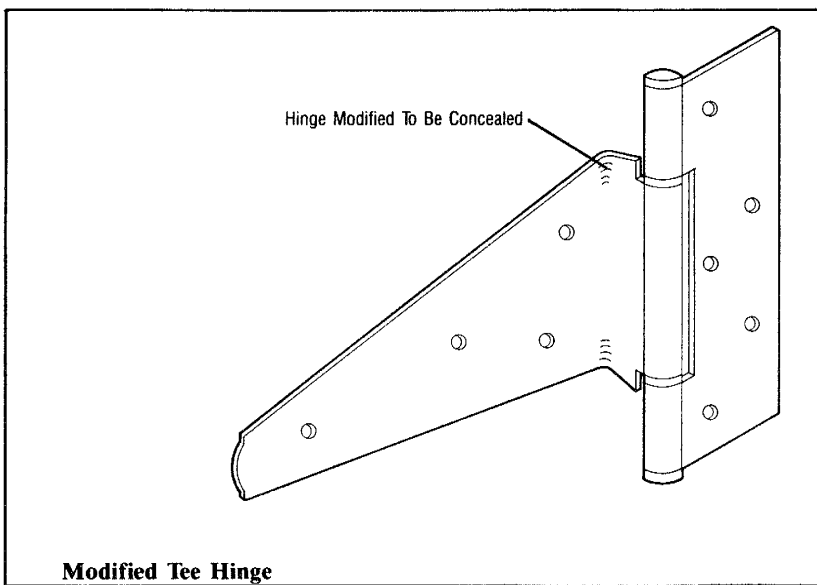
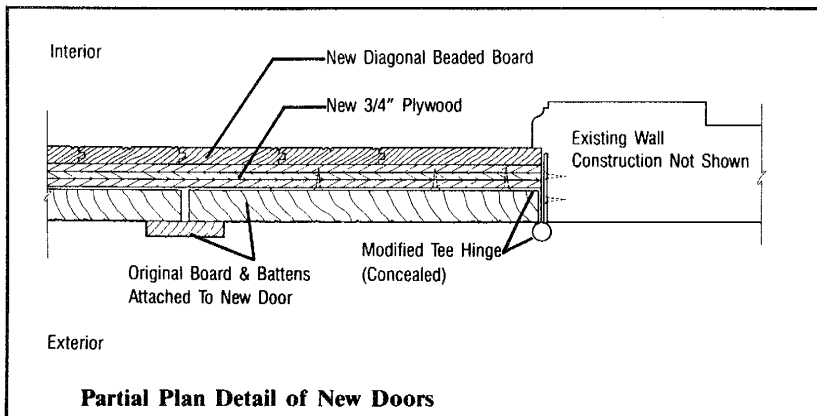

Figure 10. Drawing of the new entrance door. Drawings: Camille M. Martone

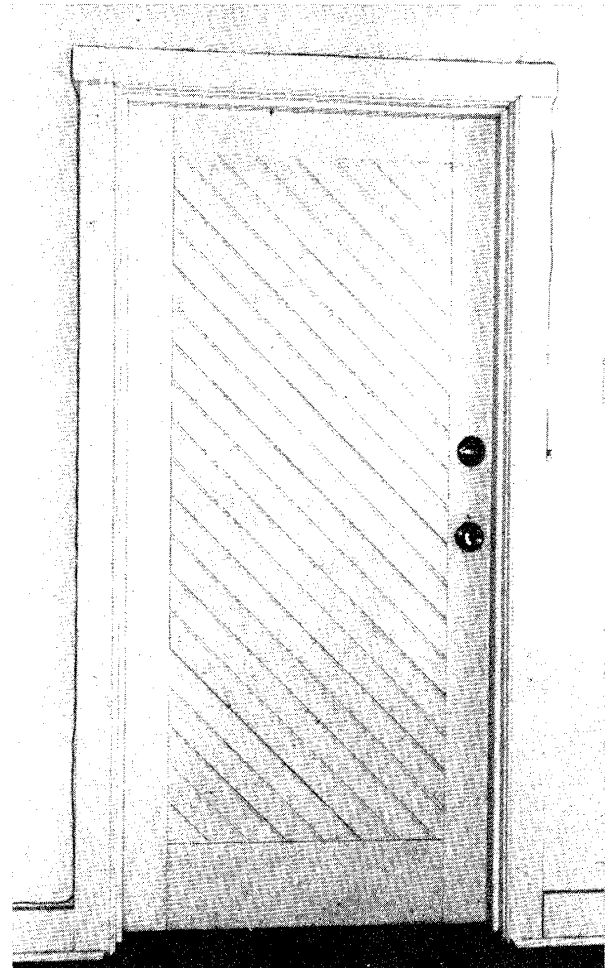

Figure 11. Diagonal boards used on the interior side of the door are in keeping with the utilitarian character of the building. Photo: Charles Fisher

PROJECT DATA:

Building:

Mountain View Motel
563 West 24th Street
Ogden, Utah

Building:

Monte Vista Fire Station
3201 Central, N.E.
Albuquerque, New Mexico

Building:

Burgess Carriage House
8444 Frederick Road
Ellicott City, Maryland

Owner:

Mt. View Limited Partnership
The Kier Corporation
Ogden, Utah

Owner:

Earl Whittemore
Albuquerque, New Mexico

Owner:

Bettie and Earl Heckman
Glenwood, Maryland

Project Dates:

February 1987-August 1987

Project Dates:

October 1984-May 1985

Project Dates:

Fall 1987

Door/Window Contractor:

Ellis Planing Mill
Ogden, Utah

Architect:

James A. "Chip" Kaufman &
Associates
Sacramento, California

Contractor:

Earl Heckman
Glenwood, Maryland

Project Cost:

\$4,000 Cost of retrofitting
20 garage doors
\$ 117 Cost of each custom window
unit (does not include installation)

Project Cost:

\$365 Installation of
glass in doors

Project Cost:

\$ 90 Materials
\$120 Labor

This PRESERVATION TECH NOTE was prepared by the Division of Cultural Resources, Rocky Mountain Regional Office, National Park Service. Charles E. Fisher, Preservation Assistance Division, National Park Service, serves as Technical Coordinator for the PRESERVATION TECH NOTES. Information for rehabilitation of the projects was provided by Stan Stradley, The Kier Corporation, owner, and Barbara Murphy, Utah State Historical Society (Mountain View Motel); Carey Rayner, project manager, and Robyn Powell, New Mexico Historic Preservation Division (Monte Vista Fire Station); and Charles Fisher, National Park Service and Earl Heckman, owner (Burgess Carriage House).

PRESERVATION TECH NOTES are designed to provide practical information on innovative techniques and practices for successfully maintaining and preserving cultural resources. All techniques and practices described herein conform to established National Park Service policies, procedures, and standards. This Tech Note was prepared pursuant to the National Historic Preservation Act Amendments of 1980 which direct the Secretary of the Interior to develop and make available to government agencies and individuals information concerning professional methods and techniques for the preservation of historic properties.

Comments on the usefulness of this information are welcomed and should be addressed to Tech Notes, Preservation Assistance Division, National Park Service, P.O. Box 37127, Washington, D.C. 200013-7127. This publication is not copyrighted and can be reproduced without penalty. Normal procedures for credit to the author and the National Park Service are appreciated.