



## ALDRIDGE HOTEL Shawnee, Oklahoma

### Introduction

With the Industrial Revolution, decorative metal canopies became a distinctive and popular form of a covered entrance for hotels, theaters, and large apartment, office, retail, and institutional buildings. They even appeared on upscale residences.

The structure of a metal canopy typically was iron, steel, wood, or a combination thereof. Attached to a building through beams set perpendicular into the exterior wall, the canopy was often supported in part by either vertical posts or overhead cables attached to the building. In its most basic form, a metal canopy consisted of an exposed metal structure with a roof and little or no ornamentation. However, it was more common to embellish the canopy with ornamentation and to provide more massing through the use of side panels. These side panels were made out of steel, zinc, copper, bronze, or cast iron.

To further enhance the prominence of a canopy by adding to the mass without significantly increasing the weight, hanging pendants made entirely of metal were often added along the perimeter of the canopy. Solid metal pendants

soon gave way in popularity to glass pendants, which consisted of a series of glass panes held in place by metal frames. Pendants came in a variety of patterns with many that mimicked the valances of the then popular canvas awning. In the late nineteenth and early twentieth centuries, this decorative feature helped characterize numerous metal canopies and marquees across the country.

Many older metal canopies with glass pendants have been lost due to building demolition, facade “enhancements,” or neglect. Some have been so altered that only the original skeletal framework remains, covered over with a contemporary skin. Even on those that have survived, the glass pendants are often in poor condition because of their typical lightweight construction, the ease by which this hanging feature could be damaged, and the general lack of proper maintenance.

In recent years, there has been an increased effort to preserve surviving glass pendant canopies and in some cases even to reconstruct missing ones. This has come at a time when the



# Preservation Tech Notes

## METALS NUMBER 6

### Repair and Reproduction of Metal Canopies and Marquees with Glass Pendants

**Lauren Van Damme**  
Technical Preservation Services  
National Park Service

**Charles E. Fisher**  
Technical Preservation Services  
National Park Service

---

*Deteriorated metal canopies with glass pendants should be maintained and repaired. In the event replacement is necessary, a new canopy should match the historic one being replaced in design, size, configuration, and detail.*

design of contemporary metal canopies for new construction has often drawn upon the form and expression of these earlier ones. In working with historic canopies, it is important to understand that mechanisms of deterioration and repair approaches are very different, depending on the materials involved and whether the metal components are cast or sheet metal.

The recent rehabilitation of the historic Aldridge Hotel in Shawnee, Oklahoma, provides a good example of both how to repair an old glass pendant metal canopy and how to replicate a missing one.

## Background

The Aldridge Hotel (originally the Hilton Phillips Hotel) was known as Shawnee's "first real skyscraper." Completed in 1929, the 10-story Neoclassical Revival building served as the city's premier hotel for many years. The hotel began to decline in the 1970s and was eventually used as a low-rent apartment/hotel facility before closing in 1994. In the years immediately following, the vacant building fell into further disrepair, suffering fires and vandalism.

In 2000, the Aldridge Hotel was listed in the National Register of Historic Places. ERC Properties of Fort Smith, Arkansas, acquired the property and undertook a rehabilitation that began in 2003, converting the hotel to affordable

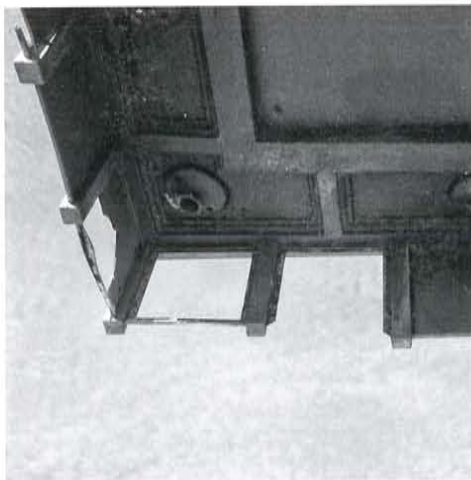

Figure 2. The underside of the main canopy's left corner, showing damage to copper pendant frames and missing glass.

housing, utilizing the Federal Historic Preservation Tax Credits. At the start of the rehabilitation, one of the hotel's two original copper entrance canopies had survived. The developer decided to repair the existing canopy and replicate the missing one, helping to preserve and recapture the historic grandeur of the building's entrances.



Figure 1. The Aldridge Hotel's south main entrance canopy as it existed at the start of the building's rehabilitation.

## SOUTH MAIN ENTRANCE CANOPY

The south main entrance canopy included a center coffer shape that followed the contour of the top of the entranceway to the building. Anchored to the building with steel I-beams and aided by the support of two cables from above, the metal and wood structure was encased with copper. The perimeter of the canopy consisted of a row of copper panels and molding trim, beneath which a row of glass pendants was attached.

## Problem

By the time the rehabilitation work began, the main entrance canopy had suffered years of neglect and decay (see figure 1). The entire canopy had been painted green, masking the structure's original patina, ornate stamped ceiling, and colored glass pendants. Since the canopy was encased in copper, it was not possible to visually establish the condition of its internal structure. However, it was evident that the glass pendants located at the corners and along the sides were either missing or cracked. The pendant frames were also bent, twisted, or broken off (see figure 2).

The project manager for the building rehabilitation understood that finding an experienced metal contractor capable of doing the work was critical to the project's success. Given the

specialized nature of the work, the project manager searched for an experienced metal contractor and obtained references from an ornamental sheet metal supplier. Such suppliers or even ornamental sheet metal manufacturers are knowledgeable of the craft skill needed for such work and can recommend experienced companies. A roofing and sheet metal company out of Oklahoma City was selected for the project work.

## Solution

The initial task of the sheet metal contractor was to establish the condition of the canopy and determine what could be repaired and what needed to be replaced. The contractor began by surveying the copper cladding that covered the roof, sides and underside of the canopy structure. Since paint was covering the copper cladding, the decision was made to remove the non-historic paint to allow for a more thorough condition assessment.

Upon removal of the paint, it was evident that the archway and canopy roof were in sound condition. Ferrous armatures and attachments were inspected for rust since copper sheet is cathodic to iron. Approximately 40% of the glass pendant frames located along the canopy's sides required replacement and the canopy's galvanized metal ceiling needed to be repaired. It was also decided that all the glass panes would need to be replaced in order to

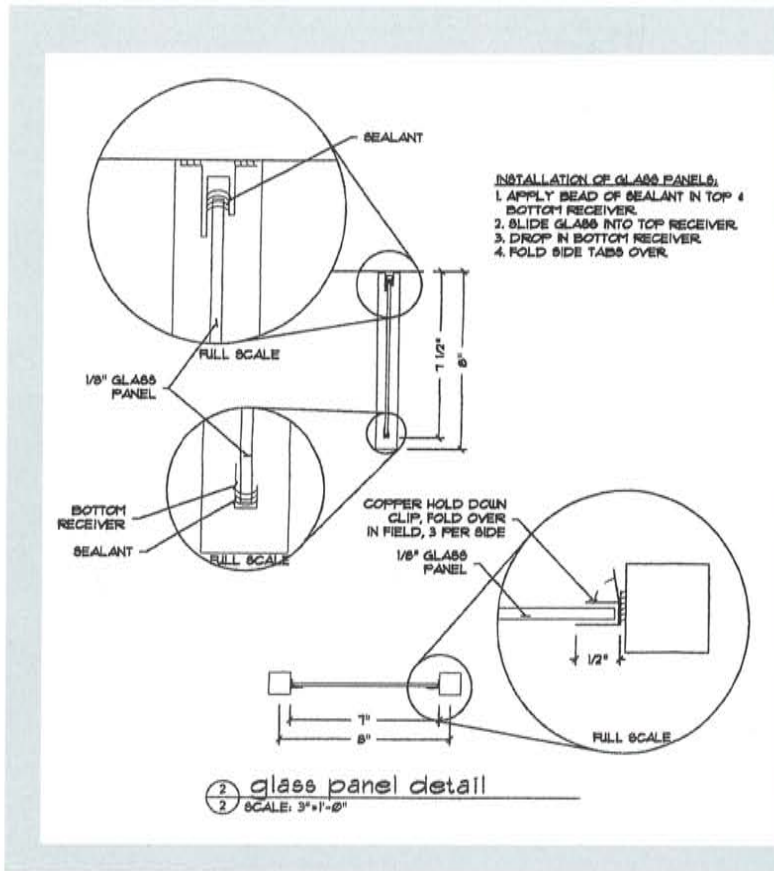

Figure 3. Details of the proposed replacement pendant frame, including how the pendant glass was to be installed. Drawing: The Hill Firm.

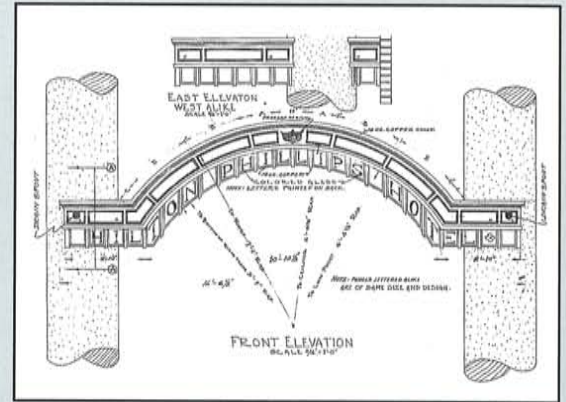

Figure 4. Original drawing for the main south entrance canopy for the Hilton Philips Hotel, later named the Aldridge Hotel. Note the lettering along the front glass panes. Drawing: Courtesy of the Hill Firm.

meet code, as the existing glass was not tempered. Because of the extent of needed repairs, both the left and right corners and side sections, along with the ceiling panels, were completely dismantled and taken to the contractor's shop. Upon removal of these sections, it was discovered that the wood frame to which the copper was attached had rotted as a result of water seepage and needed to be replaced.

After transporting the dismantled canopy sections back to the shop, the sheet metal contractor took measurements of the existing pendants that were in good condition. Along with the canopy's original drawings, these measurements were used to create a pattern for the needed replacements. The design for the pendant, measuring 7 1/4" x 7 1/4" and made of 16 oz. copper, resembled a picture frame. At the bottom of the frame, a U-shaped channel provided a bottom receiver for the glass to help hold it in place. An extended U-channel was used along the top, providing extra room so the glass pane could slide up out of the bottom channel for replacement when broken. Affixed to the backside of the frame were four 1/2" copper clips, two on

each vertical side, which when folded over the glass, helped secure the lights in place (see figure 3).

After cutting and shaping the metal pieces, the new pendant frame was soldered together. Each frame was then soldered to the dividing posts between each pendant. These 1" square copper posts served as the connector between each pendant and provided structural strength for the row of glass pendants. At the top of each pendant frame, the metal sides included a flange at the upper end that enabled it to be affixed with screws to the underside of the canopy. An additional section of copper panned over the flanges provided for a weather tight seal.

In addition to creating replacement frames for the broken and missing glass pendants, repairs were made to the existing copper cladding covering the canopy frame. The contractor straightened out copper that had been bent or twisted. New copper pieces were sleeved over damaged pieces or made to span missing portions, and then were soldered in place. Copper pop rivets were used to attach pieces where sleeving was not practical. To

prevent future water leakage and damage, considerable overlapping of panels and trim of the copper cladding was necessary.

Once the corner and side sections had been transported back to the building and reattached to the main canopy, the next and final step in repairing the canopy was the replacement of the pendants' glass panes. For the necessary re-glazing, the sheet metal contractor brought in a glass company. The old glass panes were removed by hand and replaced with tempered glass panes. Those along the coffered ceiling required special cutting on a radius.

To install the new panes, a bead of clear silicone sealant was applied in the top and bottom of the metal frame, helping to secure the glass and prevent it from rattling in heavy winds. The glass was then slid into the top receiver and set into the bottom. The side tabs located on the back of the pendant frame were folded over to secure the glass. Since the original drawings showed the building's name painted on the back of the glass panes, this signage was recreated with the current name, the Aldridge Hotel (see figure 4).

## Zinc and Galvanized Steel Canopies and Marquees

Canopies and marquees covered with zinc or galvanized steel were common in the early twentieth century. Stamped metal pieces and ornament were advertised in numerous manufacturers' trade catalogues. Local sheet metal fabricators could purchase the decorative pieces and incorporate them into the sides and ceilings of canopies being designed for specific buildings. The roofs would be covered in metal or assembled with large glass panels to provide natural light to pedestrians below.

Ornamental glass pendant frames came in two general types, single or double faced. Single-faced pendants were similar to the Aldridge Hotel's copper pendants in that the backside was "open," allowing the glass to be easily repaired. Yet many zinc and galvanized steel pendants were double-faced, with matching front and back sections soldered together along the edge. The glass was sandwiched in-between.

Of particular interest in undertaking repairs is that the face of larger individual frames often were not stamped out as a single unit. Rather a stamped face as supplied by the manufacturer consisted of the left and right halves of two adjacent pendants. The joint where two single-faced pendant frame pieces were soldered together to create a full pendant (and halves of two adjacent pendants) is usually evident upon close examination. On smaller frames, a single stamped piece could include two or more complete pendant faces.

When working with historic glass pendants, it is important to ascertain how they were

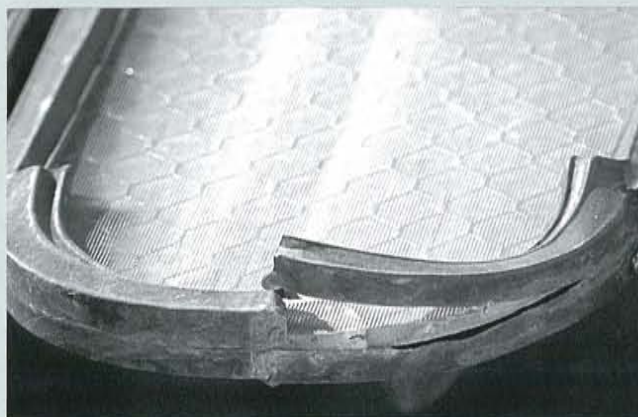

**Figure b.** In this double-faced pendant, the soldered joint on the outer face has failed where two adjacent pendant halves are connected.



**Figure a.** Rust, paint failure, open joints, broken glass, or damaged and missing sections are indications that pendant frames are in need of repair.

assembled and attached to the canopy. Just as the copper pendants described in this Tech Note, galvanized steel and zinc pendant frames often were attached to the canopy with screws through a flange on the top of each pendant frame. Yet there are numerous other ways the pendants were attached. One method involved setting the pendants so that just the horizontal part of the pendant frame at the top was aligned against the side of the canopy at the lower edge. This allowed for the pendants to be attached to the canopy with a screw through the top outside face of the pendant rather than through a flange. A simple trim piece would then be attached, running along the length of the top edge of the pendants so as to provide for a weather tight seal. Another

method of attachment involved a lock seam formed by the sheet metal covering the lower edge of the box frame. This continuous seam would run horizontally at the location where the pendant frames were to be attached. The flanges at the top of the glass pendant frames would be folded and then slipped into this horizontal lock seam, securing the pendants to the canopy.

How to remove a section of the pendant for shop repairs depends, in part, on the way the pendants are attached to the canopy. It is necessary first to remove, if present, the long metal cap or trim piece covering the top edge of the pendant frame. If the pendant frames are attached with screws to the canopy, the screws need to be removed. Some unsoldering of existing connections will be necessary as well.

Rust, paint failure, open joints, broken glass, or damaged and missing sections are indications that pendant frames are in need of repair. When the pendant frame is in reasonably good condition, it may be possible to make necessary repairs on-site. Where more extensive deterioration has occurred or where the wood substructure has deteriorated, sections of the canopy usually are removed and taken to a shop for repair or replacement work.

**Rust:** It is not uncommon for rust to appear on galvanized steel pendants. This occurs where the coating has failed, typically at failed joints or where the pendants have been damaged. The rust should be removed and the metal coated with a zinc oxide primer and then repainted.

**Paint failure:** When more extensive repairs are needed or where the paint is heavily built-up or failing, it may be necessary

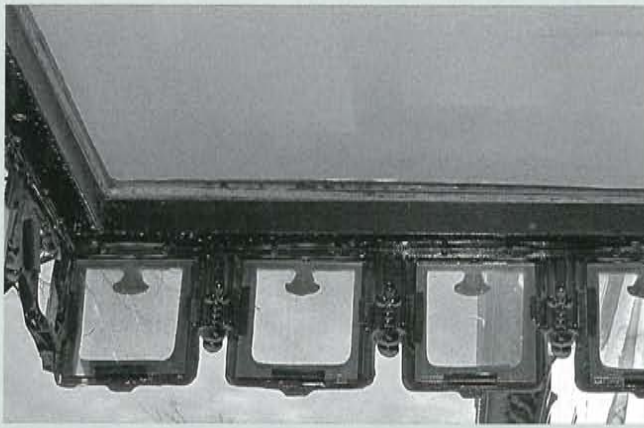

**Figure c. Broken glass in single-faced pendants can be easily replaced from the back side, where the glass is held in place by metal tabs, as shown above, or by glazing putty.**

to remove the paint, after first recording the historic paint colors. Besides taking appropriate precautions for the presence of lead paint, care should be taken to minimize damage to the old galvanized coating and the metal itself. Any method of paint removal that is being considered should first be tested on the canopy at an inconspicuous location and an assessment made as to whether it is the least damaging method. Mechanical and chemical removal techniques cause particular problems for zinc sheet stampings. (Zinc is not resistant to acidic or strong alkaline solutions.) Both stamped zinc and galvanized steel should be repainted.

**Open joints:** Metal joints connect individual pieces of the pendant frame. Where joints have opened up, water can seep inside and cause eventual rusting of the galvanized steel. In colder climates, metal deformation can occur from water freezing and expanding within the frame. Open joints should be cleaned, aligned, and re-soldered rather than simply filling voids with caulk or other sealants.

**Broken or missing glass:** Glass breakage can result from stones and other airborne objects; deformation in the pendant frame from entrapped moisture that freezes and thaws; and impact from tall service vehicles or mechanical lifts. Glass in pendant frames that are open in the back are the easiest to replace since they are secured by exposed metal tabs. For most double-faced pendant frames, the glass originally was installed as the frame was soldered together. The recommended procedure is to detach the individual pendant frame from the canopy

and unsolder the connection with adjacent pendants. This allows for the individual pendant to be taken down, the old glass removed and measured, and new glass installed. With some pendants, the removal of individual ones is problematic and it may be possible to undertake the work in place. Alternately, it may be necessary to remove one or more pendants and replace them with new ones.

This is often the case with frames made of stamped zinc sheet. Where numerous glass pendants are cracked or missing, an entire row of pendants may be removed and the necessary glass replacement undertaken in a shop facility.

**Deteriorated, damaged or missing pendant frames:** Depending upon their condition, it may be possible to remove old galvanized sheet metal elements to make repairs in the field or shop. Old stamped zinc is more difficult to repair. Long-term exposure to acid rain leads to deterioration, resulting in the zinc sheet being thinned and perforated. This tends to occur where water ponds, such as the bottom of the pendant frame. While new zinc sheet stampings may be bent or molded as needed to install, existing zinc stampings generally fatigue and fracture with a small amount of movement. As a result, when zinc pendant frames cannot be repaired in place, it usually will be necessary to replace them with new ones.

Where sections of the pendant frame are damaged or beyond repair, there are a number of possible steps that can be taken to correct this condition. Some of the old patterns of metal pendant frames are still manufactured so new matching replacement pieces may be available. Where various pendants are missing or damaged and matching new pieces are not available, it may be possible to purchase a similar pattern and group the new pieces on the sides back toward the building. Another alternative that works with some matching double-faced pendants is to scavenge needed sections by removing the backs of existing ones and using them

to complete the row of pendants. With this approach, metal tabs like those used at the Aldridge Hotel would need to be attached to the backside to secure the glass in place. A clear sealant may also be needed. If only a few sections of a metal pendant frame are missing, the removal and reuse of the end pendants on each side closest to the building is the most practical solution.

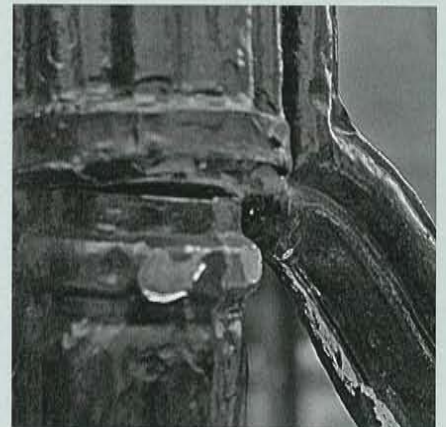

**Figure d. Typical deteriorated conditions on pressed, galvanized metal pendants can include broken or missing glass (top); broken or misaligned elements (middle); and rust along the bottom of the pendant frames where water has collected (bottom). These conditions can usually be repaired.**

## History of Decorative Glass Pendants

Early examples of decorative pendants date back to the mid-nineteenth century. Pendants originally were made of cast-metal frames with metal panels and were used for a number of decorative purposes, as illustrated in the 1882 Illustrated Catalogue of Macfarlane's Castings (*see illustration*). The use of solid metal "drops" eventually extended beyond bandstands and window hoods and began to appear on the perimeter of entrance canopies.

While solid metal drops first appeared on canopies, glass pendants became almost a standard feature by the turn of the century. Clear glass was the predominate choice, but colored glass was used as well to enhance, for example, the marquees of early movie houses. Wire glass also was used because of its durability and shatter-resistance, making it a common selection for highly trafficked downtown areas.

The popularity of glass pendants in the early twentieth century also coincided with the increasing use of commercial lighting on buildings. Soon the electric light bulb was being added to metal canopies either to simply enhance the basic lighting at the entrance to a building or to attract customers inside. On department stores and other retail buildings, it was not uncommon to find a row of light bulbs set directly behind a row of pendants, with each light centered on a glass pane.

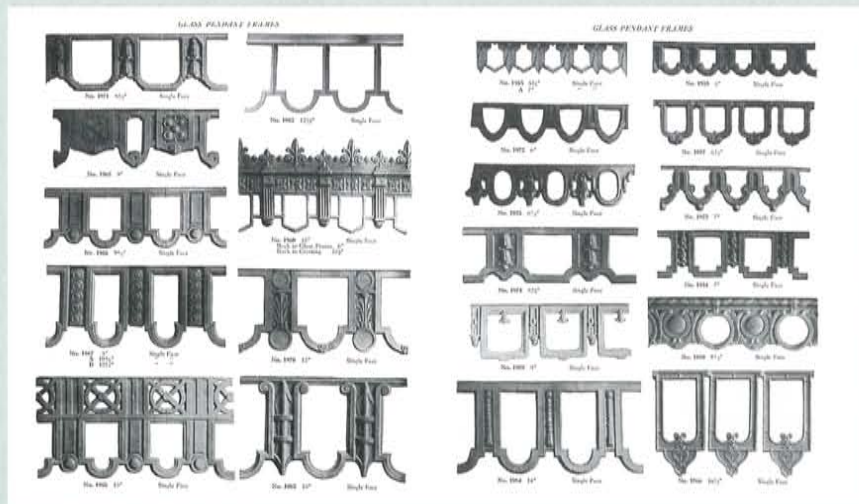

The 1882 Macfarlane's catalog shows various uses of solid metal pendants as embellishments on coverings, such as garden shelters (bottom). A variety of stamped metal pendant styles shown in this turn-of-the-century manufacturer's catalog are still available today for repair and replacement work (top). Courtesy of W. F. Norman Corporation (top). Courtesy of Historical Arts and Castings, Inc (bottom).

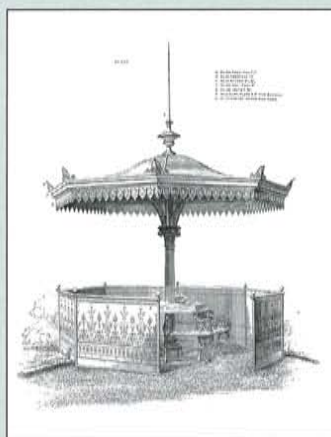

Glass pendant frames were popularized and typically marketed in the trade catalogues of architectural sheet metal manufacturers. Some catalogs featured drawings or photographs of completed canopies and marquees while others depicted individual pendant styles that were available. A variety of pendant styles are found in a turn-of-the-century catalog of the Miller & Doing Company, Brooklyn, New York (*see illustration*). This catalog featured over 20 glass pendant frames, ranging in height from 5 to 16 1/2 inches. Many of the old Miller and Doing's sheet metal ornaments, including the glass pendant frames, are produced today by the W. F. Norman Corporation.

## EAST ENTRANCE CANOPY

### Problem

While a simple shed canopy existed at the east entrance at the start of the building rehabilitation, it was poorly constructed and in deteriorated condition (*see figure 5*). Physical evidence of the original canopy fortunately had survived. The pockets remained in the masonry wall that once carried the supporting beams and the historic overhead cables and anchors still were in use. The flat roofline of the original canopy clearly was evident against the building, cutting right below the transom over the doors. Furthermore, ghost marks on the brick wall helped to establish the height of the box canopy frame.

Historic photographs of the original canopy confirmed that it was flat shaped, unlike the one at the main entrance. They also showed that glass pendants were hung below the metal panels. While there was enough information from the physical evidence and pictorial records to recreate the canopy, this project benefited from the existence of the historic south main canopy and the original drawings of the south canopy. Based on the available information, the project team decided to recreate the original canopy design.

### Solution

The new canopy consisted of a metal sub-frame, upon which a wood frame made of exterior grade plywood was attached. For the canopy cladding,

16 oz. copper was used along the top and sides. To match the patina of the existing canopy on the main entrance, the new canopy was chemically treated.



Figure 5. The east canopy entrance prior to the fabrication of its replacement. The original canopy had been replaced long ago with a simple covering that had deteriorated as well.

## Iron, Steel, and Bronze Canopies

Canopies fabricated of cast iron predate the more common stamped-metal and sheet-metal covered ones. Canopies made largely of cast iron, and later bronze and steel, continued in use throughout the popular era of the glass pendants.

As with sheet metal and stamped metal canopies, those made primarily of cast iron, bronze or steel were embellished with a variety of glass pendant styles. The cast-metal pendant frames tended to be thicker than sheet metal and often they were single-faced with an open back. Because the frames were thick, glass in single-faced pendants could simply be set in place using glazing putty on the backside. This glazing technique allowed for easy on-site glass replacement. The beveled putty edge would be painted the same color as the frame so as to be inconspicuous.

Other cast pendants consisted of two faces, the outer one often thicker than the one attached to the back. The back face helped to secure the glass in place and provided for a finished appearance. The back face was usually attached to the front with machine screws.

A canopy with glass pendants often consisted of individual pendant frames that were assembled in a row by connecting each pendant frame to an adjacent one and as well as connecting each to the canopy frame at the top. One common method of assembly involved three connections, one at the top of the pendant frame, usually on the backside, through which a screw was set, securing the pendant to the canopy frame. The other two consisted of flanges located one each on the two sides of the pendant frame, which were screwed to corresponding connectors on adjacent pendant frames. Steel frames could also be welded to each other.

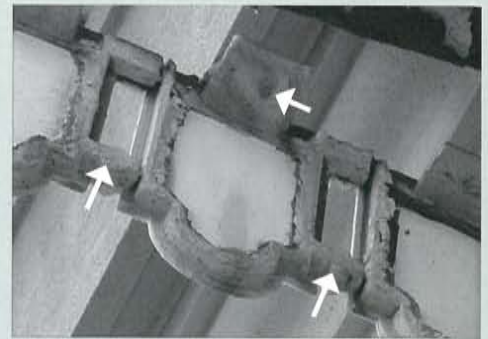
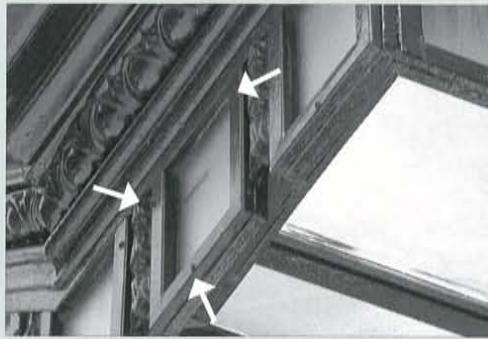

With the simple double-faced pendant frames on the left, the front and back faces are screwed directly to each other as indicated by arrows. The pendants on the right are single faced with the glass held in place by putty. Each pendant is secured to the top of the canopy and to adjacent pendants. Screw connections are indicated by arrows.

Some pendant frames may have fewer connections because they were cast in larger units, such as four pendants in a row. Canopies with a coffered shape were the most complicated to assemble because of the graduated size of the glass pendants. This necessitated numerous sizes of individual pendants be used.

Cast pendant frames are sturdier than those of sheet metal and tend to be in better condition today. Cast-iron and steel canopies need regular painting to deter rust. Zinc rich primers are usually applied to cast iron. A high build epoxy can then be used followed by two coats of a polyurethane finish. Bronze canopies were often left to patinate naturally. Today, they are sometimes coated with an acrylic urethane or a lacquer formulated for copper alloys.

Methods of cleaning and repair will vary according to the type of material involved—cast iron, bronze or steel. In reproducing a historic canopy or making extensive repairs to one that has been damaged, new pendant frames can be cast to match existing ones using in-kind material and traditional techniques. Alternatively, aluminum is commonly used today as a substitute material for cast iron in making repairs requiring replacement pieces and to reproduce missing cast-iron and steel canopies.

For the ceiling underneath the canopy, stamped zinc-coated steel panels and trim were obtained from a company still manufacturing traditional designs.

In fabricating the new glass pendants, the same 7 1/4" x 7 1/4" pattern found on the main entrance was used. During installation of the new canopy, plywood squares were used as placeholders for the new glass, which was not installed until after the canopy had been secured to the masonry wall.

The greatest challenge in recreating the missing canopy came about during its installation. Since the entire canopy had been fabricated in the shop, a special crate was made to transport

the structure safely to the building. The contractor then used a lift to set the canopy into place (see figure 6). The entire process had to be handled with care, given the vulnerability of the canopy's soft copper skin and the hanging pendant frames.

## Evaluation

The canopy work at the Aldridge Hotel was successful in both repairing the historic main entrance canopy and replicating a missing one at the other entrance to the building (see figure 7). The glass pendants with electric lighting behind are once again a distinctive feature of both entrances.



Figure 6. The installation of the new canopy required the use of a Sky Track and a special harness to ensure the protection of the copper frame. Photo courtesy of Thad Jennings, JENCO Roofing & Sheet Metal.

In undertaking the repair work, it was recognized early on that due to the extent of damage to the corner pendants, this part of the work was best undertaken in a shop rather than at the site. Understanding how the canopy was originally assembled allowed the contractor to remove only the most damaged areas, while making other repairs with the canopy in place. By not removing the historic canopy as a whole, the contractor eliminated the potential damage that could be caused in shipment and re-installation.

It took almost four months to complete both the repair to the historic canopy and replication of the missing one. This was due in part to the nature of the fabrication and also that the job site was a one hour drive from the shop. As with most sheet metal canopies, those at the Aldridge Hotel were assembled from many pieces of sheet metal that were soldered, mechanically fastened or otherwise attached. Such work required craftsmanship and time to complete.

## Conclusion

The glass pendants on the canopies of the Aldridge Hotel represent one of numerous types and styles that can be found on historic canopies and marquees. Depending on whether they are framed in a cast metal or in sheet copper, zinc, or galvanized steel, each

type will have specific conservation requirements due in part to the materials involved. The specific style of a glass pendant will also affect decisions concerning repair and replication. Some old patterns are still available today while others are affordable to reproduce. The pendant style will influence the ease by which they can be maintained. Single-faced pendant frames are the easiest to maintain, especially in the case of broken glass. For double-faced pendant frames, ascertaining how they were assembled is critical to undertaking successful maintenance work. Specific maintenance and repairs will be affected by how the original pendants were joined together and the glass installed.

Traditionally located at main entrances, metal canopies with glass pendants are a distinctive feature on historic buildings and should be preserved.



Figure 7. The new copper canopy on the east elevation of the Aldridge.

## PROJECT DATA

### Building:

The Aldridge Hotel  
20-24 East 9th Street  
Shawnee, Oklahoma

### Owner:

ERC Partners of Oklahoma, LLC  
Barling, Arkansas

### Project Date:

2004

### Architect:

The Hill Firm  
Fort Smith, Arkansas

### Project Manager:

ERC Construction Group  
Barling, Arkansas

### Canopy Contractor:

JENCO Roofing & Sheet Metal  
Oklahoma City, Oklahoma

### Copper Supplier:

Copper Craft  
Keller, Texas

### Stamped Metal Ceiling:

W.F. Norman Corporation  
Nevada, Missouri

### Project Costs:

The total cost of repair for the existing canopy was approximately \$28,500. The cost to replicate the smaller side entrance canopy was \$28,000.

---

This *Preservation Tech Note* was prepared by the National Park Service. Charles E. Fisher, Technical Preservation Services, is the Technical Editor of the *Preservation Tech Notes* series. Information on the Aldridge Hotel canopy work was generously supplied by Thad Jennings of JENCO Roofing and Sheet Metal. Thanks go to Robert Baird of Historical Arts & Castings, Inc. and Richard Pieper of Jan Hird Pokorny Associates for providing information about rehabilitating and replicating historic metal canopies. Thanks are also extended to Sharon Park FAIA, Michael Auer, and Chad Randl of the National Park Service for their review and assistance. Unless otherwise noted, photographs are from NPS files or by the authors.

*Preservation Tech Notes* are designed to provide practical information on traditional and innovative techniques for successfully maintain-

ing and preserving cultural resources. All techniques and practices described herein conform to established National Park Service policies, procedures and standards. This *Tech Note* was prepared pursuant to the National Historic Preservation Act, which directs the Secretary of the Interior to develop and make available to government agencies and individuals information concerning professional methods and techniques for the preservation of historic properties.

Comments on the usefulness of this information are welcomed and should be addressed to *Preservation Tech Notes*, Technical Preservation Services-2255, National Park Service, 1849 C Street NW, Washington, DC 20240.